

RAE 60

cable tray attachment corner, height = 60 mm

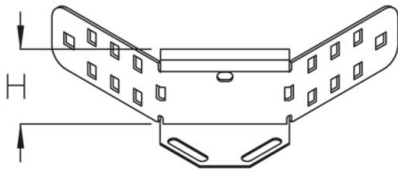

Continuously hot galvanized (Sendzimir process) (DIN EN 10346)

Product	H	G
RAE 60S	60 mm	0,3 kg
incl.:		
3x KLR	clamp fastening set	

Hot-dip galvanized, according to BS 729 (DIN EN ISO 1461)

Product	H	G
RAE 60F	60 mm	0,3 kg
incl.:		
3x KLR E	clamp fastening set	

Stainless steel, according to ASTM 304 / BS 304 S 3

Product	H	G
RAE 60E	60 mm	0,3 kg
incl.:		
3x KLR E	clamp fastening set	

H: height



G: weight

DETAILS / APPLICATIONS

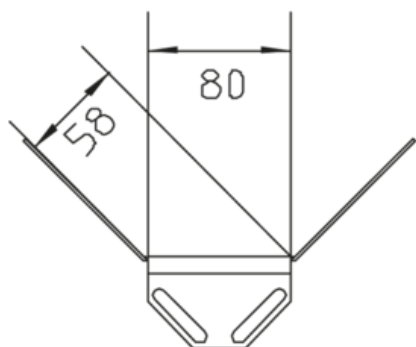

OPTIONAL ACCESSORIES

VB, RAED, RTRV 60

