

AVB 82

jointing bracket Omega

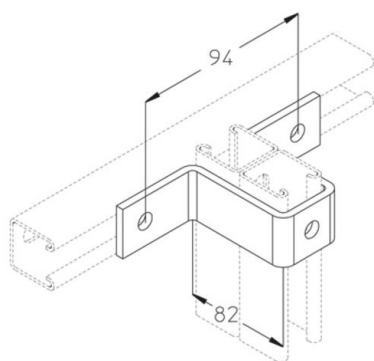

Hot-dip galvanized, according to BS 729 (DIN EN ISO 1461)

Product	H	B	L	t	G
AVB 82-HDG	90 mm	134 mm	40 mm	6,00 mm	0,48 kg

Stainless steel, according to ASTM 31 Ti / AISI 316 L, BS 320S17 / BS 316S11

Product	H	B	L	t	G
AVB 82-316	90 mm	134 mm	40 mm	6,00 mm	0,48 kg

H: height
B: width
L: length
t: material thickness
G: weight

DETAILS / APPLICATIONS



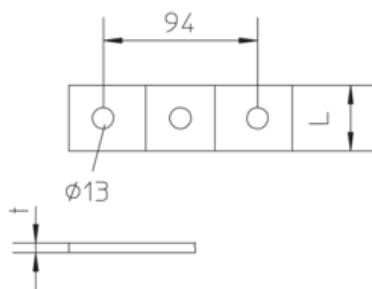

OPTIONAL ACCESSORIES

KHA 82

